

User Guide



Version 1.02-25

USER GUIDE

CONTENT

<u>1. Meet your Dolphin Smart tracker Huthur ...</u>	<u>1</u>
<u>2. Set up your Dolphin Smart tracker Huthur.</u>	<u>2</u>
<u>3. Battery Replacement</u>	<u>4</u>
<u>4. Additional Tips.....</u>	<u>5</u>
<u>5. FAQs.....</u>	<u>6</u>
<u>6. Technical Specifications.....</u>	<u>7</u>
<u>7. Know Your Battery.....</u>	<u>8</u>
<u>8. Disposal.....</u>	<u>8</u>
<u>9. Warranty Provision & Period.....</u>	<u>8</u>

1. MEET YOUR DOLPHIN SMART TRACKER HUTHUR



Side A



Side B

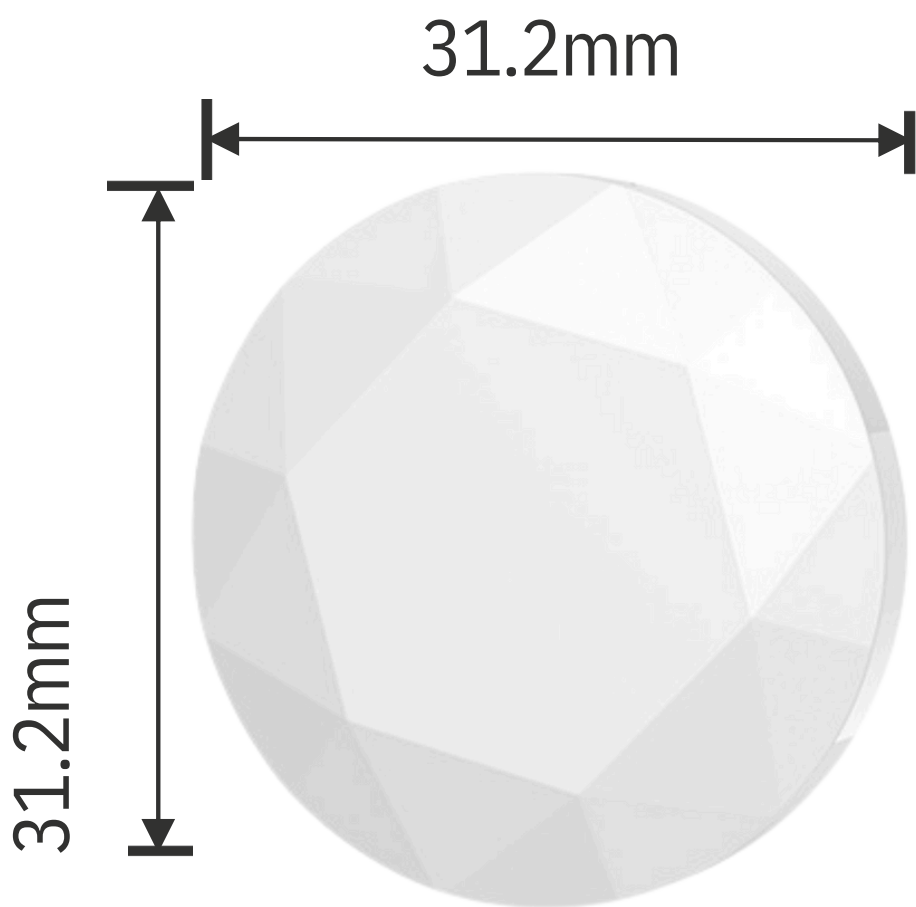

Side A

Side B

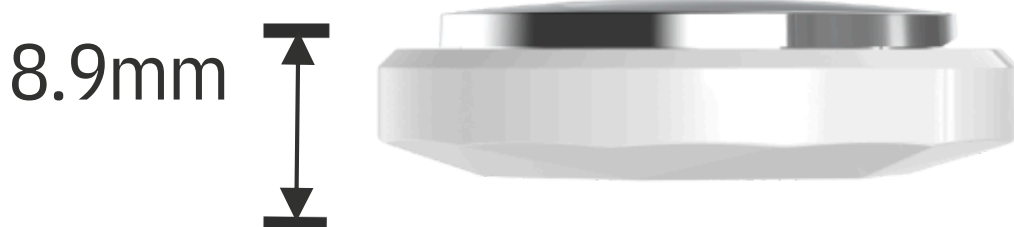

2. SET UP YOUR DOLPHIN SMART TRACKER HUTHUR

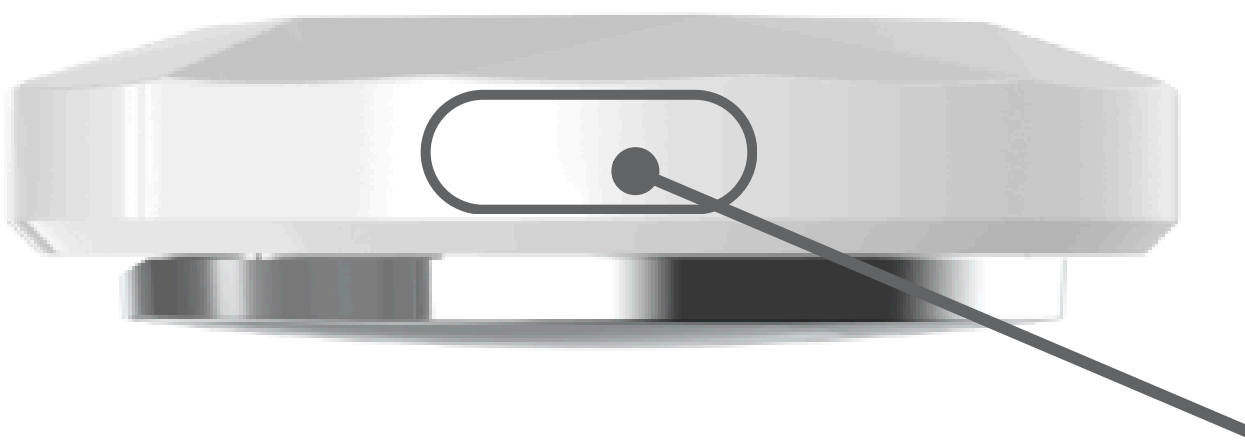

Power button

Step 1. Power On

Hold the button (approximately 2s) and release until a single beep heard, indicating the device is powering on.

Step 2. Power Off

Hold the button until you hear a single beep, followed by two consecutive beeps, and then three continuous beeps. Release the button after hearing the continuous three beeps (approximately 6 seconds), indicating the device is powering off.

Step 3. HOW TO PAIR



Figure 1



Figure 2

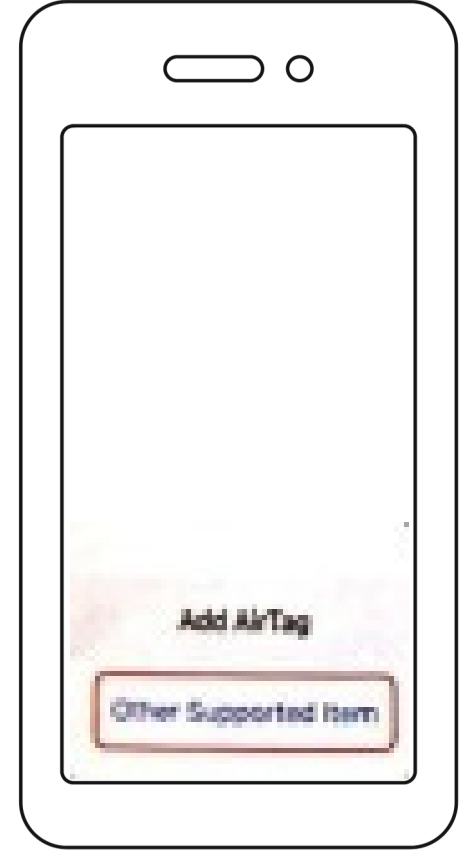

Figure 3

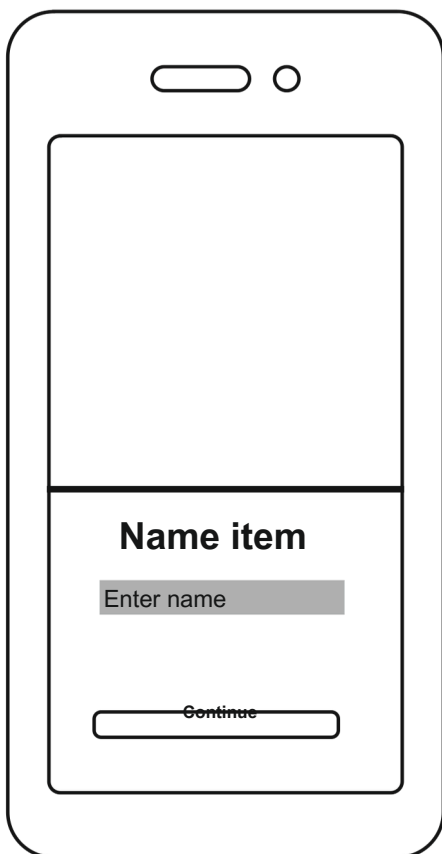

Figure 4

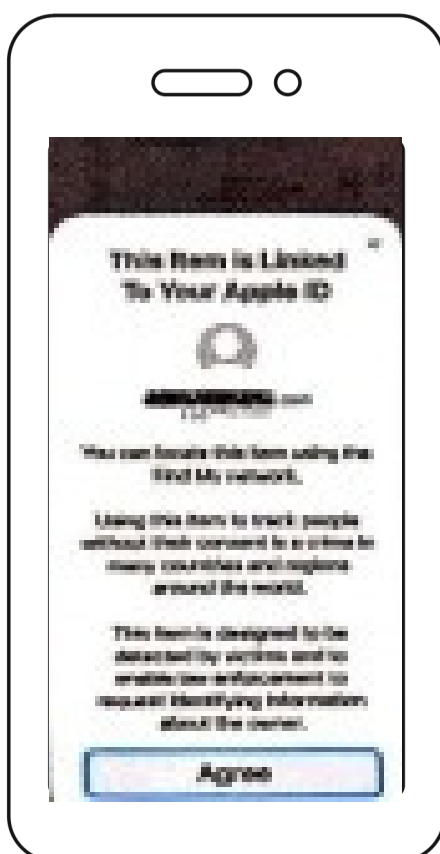

Figure 5

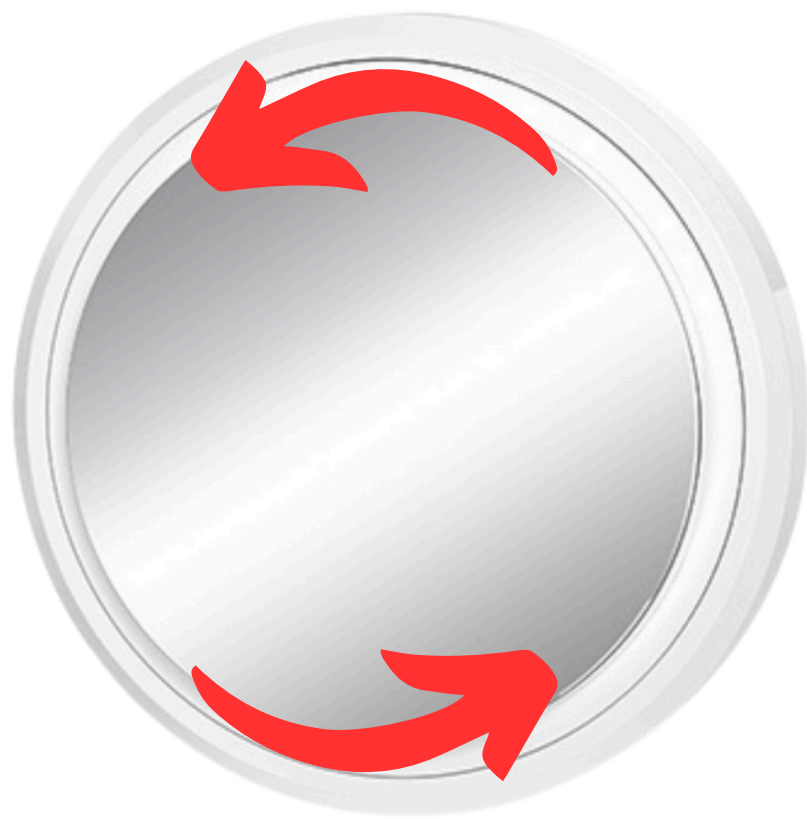

Figure 6

1. Place the FINDER next to your Apple device like iPhone.
2. Turn on Bluetooth on iPhone and connect to Internet.
3. Press the finder side button, hear one beep to power on.
4. Open the 'Find My' app as shown in Figure 1
5. In 'Find My' app, click on Add Item Figure 2- Other Support Items. As shown in Figure 3.

6. Name your Finder and click 'Continue'. As shown in Figure 4.
7. Select emoticons.
8. "This item is linked to your Apple ID. To proceed, review and agree to the required terms." Figure 5.
9. Click 'Continue', then click 'Finish' to complete Figure 6.

3. BATTERY REPLACEMENT



1. Twist anti-clockwise to open the back cover.
2. Replace the battery with a new CR2032 battery.
3. Twist clockwise to close the back cover securely.

4. ADDITIONAL TIPS

4.1 Switching to Disable Mode (Airplane Mode)

To switch from Active mode to Disable mode (Airplane mode), simply remove the battery.

4.2 Switching Back to Working Mode

To switch from Disable mode (Airplane mode) to Working mode, reinstall the battery. The FINDER will automatically pair successfully.

4.3 Factory Reset

Press and hold the button until you hear:

- 1 consecutive prompt tone then
- 2 consecutive prompt tones then
- 3 consecutive indicator tones

Continue holding for 5 seconds. When you hear a long indicator tone, release the button to restore the device to its factory settings.

4.4 Removing the FINDER from Apple Devices

To remove the FINDER from your Apple devices:

1. Open the Find My app
2. Select Items
3. Locate your device
4. Scroll down and tap Remove This Device

4.5 Troubleshooting Connection Issues

If the FINDER fails to connect to the Find My app: Follow the instructions in section 4.3 to perform a factory reset. Restart the pairing process.

5. FAQs

1. Is the battery replaceable?

No, the tracker has a built-in battery designed to last for about a year without replacement.

2. Is it compatible with iOS?

Yes, it works with iOS devices running iOS 14.5 or later.

3. Is it compatible with Android?

No, it exclusively works with Apple's Find My network on iOS.

4. How durable is the tracker?

It features a rugged, water-resistant enclosure for everyday use.

5. Can it be tracked worldwide?

Yes, it uses Apple's Find My network for global tracking.

6. Does it require a subscription?

No, there are no additional fees or subscriptions required.

7. Does it work internationally?

Yes, it operates globally without extra charges.

8. Is the setup process easy?

Yes, just bring it near your iPhone and follow the on-screen instructions.

5. TECHNICAL SPECIFICATIONS

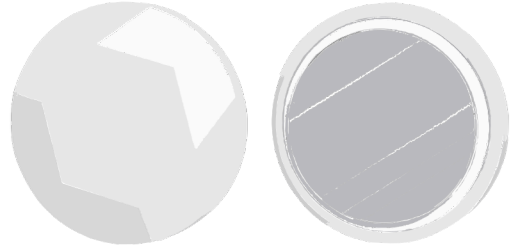
Physical Specifications	Model	
	Material	Plastic Enclosure
	Dimension LxWxT in mm	31.2x31.2x8.9
	Weight in grams	7.3
	IP Rating	IP 5X rated
	Alert Sound in Decibel	60dB~70DB
Battery Specifications	Battery Type	Cr2032 2V Replaceable
	Battery Capacity in mAh	230 mAh
	Battery Life in months	09-months
	Battery Standby in months	10-12 months
Bluetooth Specifications	Range Line of sight in Feet	~60 ft
	Range Non line of sight in Feet	~15-20 ft
	Bluetooth Version	BLE V5.0

8. KNOW YOUR BATTERY

WARNING

Fire Hazard! Do not short-circuit batteries. Batteries may overheat or explode.

WARNING

Keep batteries out of reach of children and pet. If swallowed, seek medical advice.

WARNING

Do not expose batteries to water or fire. Do not attempt to charge non-rechargeable batteries. The batteries may explode.

Ingestion: Swallowing may lead to serious injury or death in as little as 2 hours due to chemical burns and potential perforation of the esophagus. Immediately see the doctor;. Do not induce vomiting or give food or drink.

Inhalation: Contents of an open battery can cause respiratory irritation.

Skin Contact: Contents of an open battery can cause skin irritation.

Eye Contact: Contents of an open battery can cause severe irritation.

9. DISPOSAL

The packaging is made of eco-friendly, recyclable material. Please ask your local authorities about appropriate methods of disposal. Defective or empty batteries must be recycled in accordance with Directive 2006/66/EC. Return batteries and/or the device to the designated collection facility. Batteries contain toxic substances that must be treated separately from domestic waste.

10. WARRANTY

PROVISION & PERIOD

The device has been manufactured and thoroughly tested to meet strict quality standards. Consumer-inflicted damage, improper use or incorrect maintenance of the product will void the warranty. Should you experience a fault or manufacturing defect within 1 year of the date of purchase, we will repair or replace the product free of charge.

Here is the link to our DoC & all other marking certificates:

https://www.tag8.co/tag8-userguide/Declaration_of_Conformity_Doc.pdf

Your feedback matters!

Scan QR to let us know what you think



Amazon Review



For Inquiries or Assistance
contact us at support@tag8.co



Stay connected with tag8

Follow us for behind-the-scenes content and offers:



tag8_official



tag8.co
tag8.in



tag8.co
tag8.in



tag8



MAKE FINDING SMARTER™

